

DA-E570

Wireless Audio with Dock user manual

imagine the possibilities

Thank you for purchasing this Samsung product.
To receive more complete service,
please register your product at
www.samsung.com/register

SAMSUNG

features

Dual Docking Audio Speaker System

Using the system's dual docking station, dock, charge, and then play either Samsung Galaxy devices or Apple devices through the system's built-in speakers.

aptX®

aptX enables high quality Bluetooth stereo audio, delivering wired audio quality wirelessly.



LICENSE



iPad, iPhone, iPod, iPod nano, iPod shuffle, and iPod touch are trademarks of Apple Inc., registered in the U.S. and other countries.

safety information

SAFETY WARNINGS

	<div style="border: 1px solid black; padding: 5px; text-align: center;"> <p>CAUTION</p> <p>RISK OF ELECTRIC SHOCK DO NOT OPEN</p> </div>	
<p>The lightning flash and arrowhead within the triangle indicates that there is dangerous voltage inside the product.</p>	<p>CAUTION: TO REDUCE THE RISK OF ELECTRIC SHOCK, DO NOT REMOVE THE COVER (OR BACK). NO USER SERVICEABLE PARTS INSIDE. REFER SERVICING TO QUALIFIED SERVICE PERSONNEL.</p>	<p>The exclamation point within the triangle indicates that there are important instructions accompanying the product.</p>

WARNING

- To reduce the risk of fire or electric shock, do not expose this appliance to rain or moisture.

CAUTION

- Do not expose this apparatus to dripping or splashing. Do not put objects filled with liquids, such as vases on the apparatus.
- To turn this apparatus off completely, you must pull the power plug out of the wall socket. Consequently, the power plug must be easily and readily accessible at all times.

This product satisfies FCC regulations when shielded cables and connectors are used to connect the unit to other equipment. To prevent electromagnetic interference with electric appliances, such as radios and televisions, use shielded cables and connectors for connections.

FCC NOTE (for U.S.A):

This equipment has been tested and found to comply with the limits for a Class B digital device, pursuant to Part 15 of the FCC Rules. These limits are designed to provide reasonable protection against harmful interference in a residential installation.

This equipment generates, uses and can radiate radio frequency energy and, if not installed and used in accordance with the instructions, may cause harmful interference to radio communications. However, there is no guarantee that interference will not occur in a particular installation.

If this equipment does cause harmful interference to radio or television reception, which can be determined by turning the equipment off and on, the user is encouraged to try to correct the interference by one or more of the following measures:

- Reorient or relocate the receiving antenna.
- Increase the separation between the equipment and receiver.
- Connect the equipment to an outlet that is on a different circuit than the radio or TV.
- Consult the dealer or an experienced radio/TV technician for help.

Caution : FCC regulations state that any unauthorized changes or modifications to this equipment may void the user's authority to operate it.

Important Safety Instructions

Read these operating instructions carefully before using the unit. Follow all the safety instructions listed below. Keep these operating instructions handy for future reference.

- | | |
|---|--|
| <ol style="list-style-type: none"> 1) Read these instructions. 2) Keep these Instructions. 3) Heed all warnings. 4) Follow all instructions. 5) Do not use this apparatus near water. 6) Clean only with dry cloth. 7) Do not block any ventilation openings. Install in accordance with the manufacturer's instructions. 8) Do not install near any heat sources such as radiators, heat registers, stoves, or other apparatus (including amplifiers) that produce heat. 9) Do not defeat the safety purpose of the polarized or grounding-type plug. A polarized plug has two blades with one wider than the other. A grounding type plug has two blades and a third grounding prong. The wide blade or the third prong are provided for your safety. If the provided plug does not fit into your outlet, consult an electrician for replacement of the obsolete outlet. | <ol style="list-style-type: none"> 10) Protect the power cord from being walked on or pinched particularly at plugs, convenience receptacles, and the point where they exit from the apparatus. 11) Only use attachment/accessories specified by the manufacturer. 12) Use only with the cart, stand, tripod, bracket, or table specified by the manufacturer, or sold with the apparatus. When a cart is used, use caution when moving the cart/apparatus combination to avoid injury from tip-over. 13) Unplug this apparatus during lightning storms or when unused for long periods of time. 14) Refer all servicing to qualified service personnel. Servicing is required when the apparatus has been damaged in any way, such as power-supply cord or plug is damaged, liquid has been spilled or objects have fallen into the apparatus, the apparatus has been exposed to rain or moisture, does not operate normally, or has been dropped. |
|---|--|



CALIFORNIA USA ONLY

This perchlorate warning applies only to primary CR (Manganese Dioxide) Lithium coin cells in the product sold or distributed ONLY in California USA

" Perchlorate Material - special handling may apply,
See www.dtsc.ca.gov/hazardouswaste/perchlorate. "

PRECAUTIONS

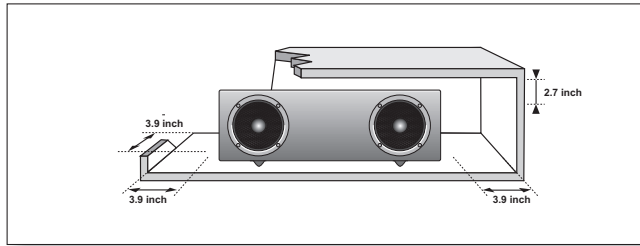

Ensure that the AC power supply in your house complies with the power requirements listed on the identification sticker located on the back of your product. Install your product horizontally, on a suitable base (furniture), with enough space around it for ventilation (3–4 inches). Make sure the ventilation slots are not covered. Do not place the unit on amplifiers or other equipment which may become hot. This unit is designed for continuous use. To fully turn off the unit, disconnect the AC plug from the wall outlet. Unplug the unit if you intend to leave it unused for a long period of time.

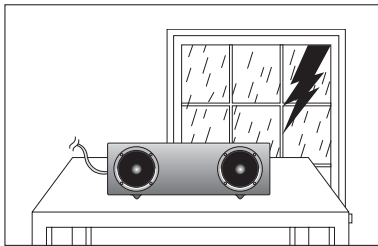

During thunderstorms, disconnect the AC plug from the wall outlet. Voltage peaks due to lightning could damage the unit.

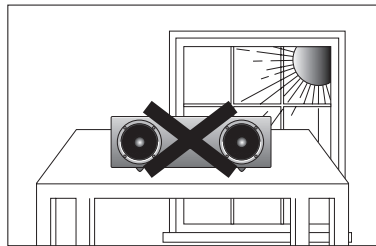

Do not expose the unit to direct sunlight or other heat sources. This could cause the unit to overheat and malfunction.

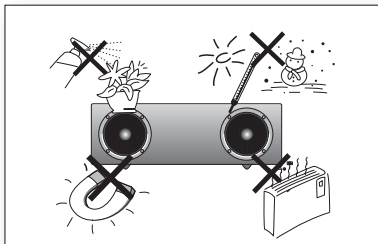

Protect the product from moisture (i.e. vases), and excess heat (e.g. fireplaces) or equipment creating strong magnetic or electric fields. Disconnect the power cable from the AC supply if the unit malfunctions. Your product is not intended for industrial use. This product is for personal use only.

Condensation may occur if your product has been stored in cold temperatures. If transporting the unit during the winter, wait approximately 2 hours until the unit has reached room temperature before using.

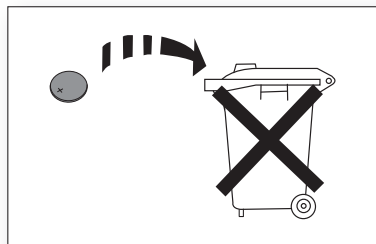

The batteries used with this product contain chemicals that are harmful to the environment. Do not dispose of batteries in the general household trash.



FEATURES	2	Features
	2	License
SAFETY INFORMATION	3	Safety warnings
	4	Precautions
GETTING STARTED	6	Before reading the user's manual
	6	What's included
DESCRIPTIONS	7	Top/Front/Rear Panel
REMOTE CONTROL	9	Tour of the remote control
POWER ON AND VOLUME CONTROL	10	Turning the Power on/off
	10	Adjusting the volume
CONNECTIONS	11	Using the Spacer Cover
	12	Connecting a device to the Dual Dock
	13	Connecting an audio device using AUX IN
	15	Connecting to Bluetooth devices
PLAYING	16	Using the docking mode with Samsung Galaxy and Apple Devices
	17	Using the Bluetooth mode
FUNCTIONS	18	Advanced functions
TROUBLESHOOTING	19	Troubleshooting
APPENDIX	20	Specifications

getting started

BEFORE READING THE USER'S MANUAL

Note the following terms before reading the user manual.

Icons used in this manual

Icon	Term	Definition
	Caution	Indicates a situation where a function does not operate or settings may be canceled.
	Note	Indicates tips or instructions on the page that help a function operate.

Safety Instructions and Troubleshooting

- 1) Familiarize yourself with the Safety Instructions before using this product. (See page 3)
- 2) If a problem occurs, check Troubleshooting. (See page 19)



Copyright

©2012 Samsung Electronics Co.,Ltd.

All rights reserved; no part or whole of this user's manual may be reproduced or copied without the prior written permission of Samsung Electronics Co.,Ltd.

WHAT'S INCLUDED

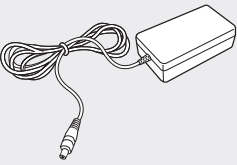
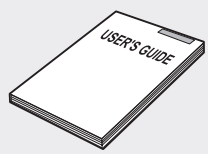
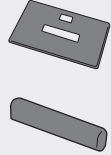
Check for the supplied accessories shown below.

		
Remote Control / Lithium Battery (3V) (AH59-02482A/4301-000108)	Power Adapter (AK44-00012A)	User Manual (AH68-02475E)
		
Spacer Cover/Protection Cover (AH63-02996A/AH63-03008A)	Cloth (BN63-02368B)	



- The appearance of the accessories may differ slightly from the illustrations above.

TOP/FRONT/REAR PANEL

<TOP>

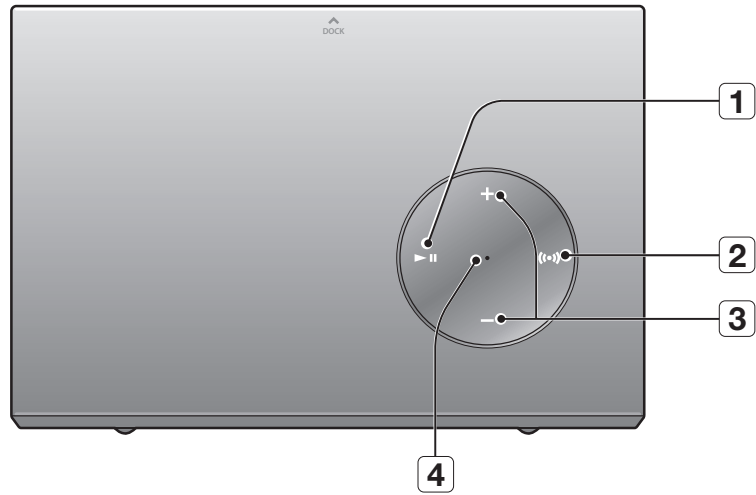

<FRONT>



<REAR>

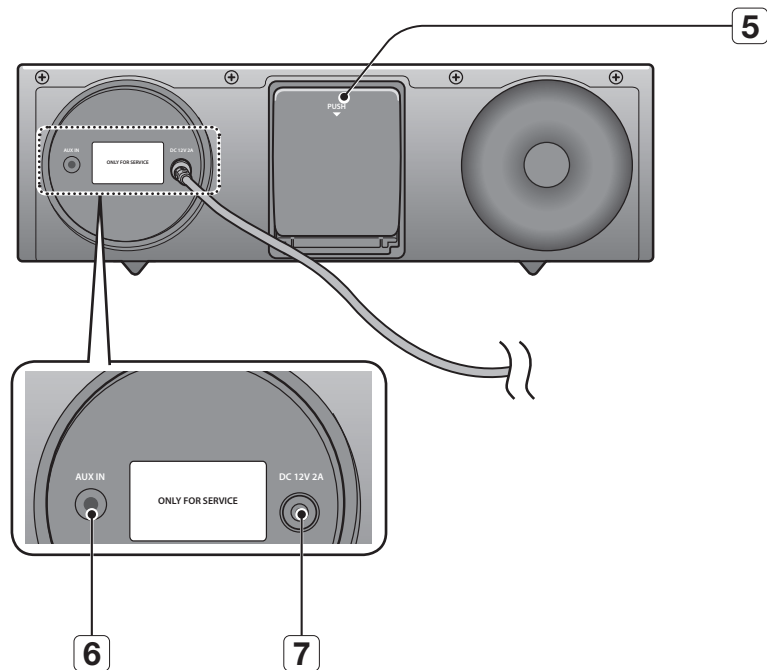

1	PLAY/PAUSE BUTTON	Play or pause a music file.
2	BASS BUTTON	Optimize the sound based on your tastes.
3	VOLUME +/- BUTTON	Controls the volume level.
4	STANDBY LED	The standby LED lights up in standby mode. The standby LED turns off when the power of the unit turned on.
5	DUAL DOCK	Provides a 5 pin dock for Samsung Galaxy devices and a 30 pin dock for Apple devices.
6	AUX IN	Connect to the Analog output of an external device.
7	DC 12V	Connect the unit's DC adapter to this jack.



- When you turn on this unit, there will be a 4 to 5 second delay before it produces sound.



- This unit can connect to mobile devices with high audio output levels. When you connect this unit to external devices with high output levels, it may lower the audio output to protect the amp and speakers.
- When disconnecting the power cable from the wall outlet, hold the plug. Do not pull the cable.

remote control

TOUR OF THE REMOTE CONTROL

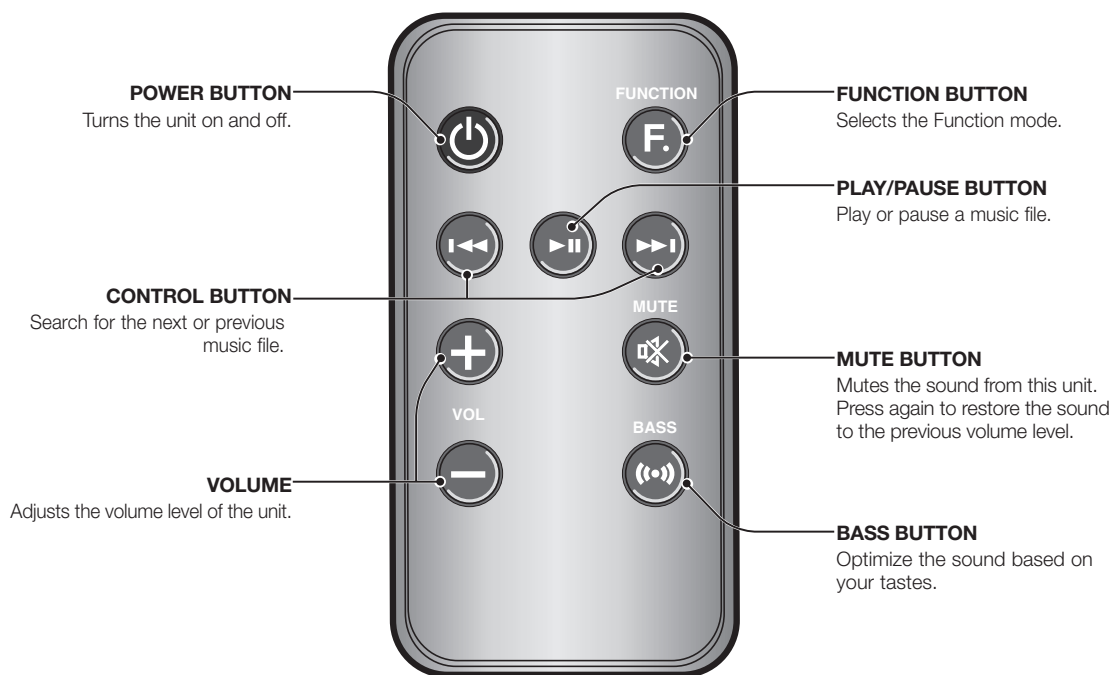

Installing battery in the Remote Control

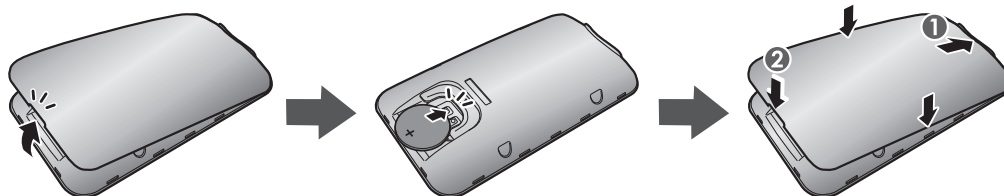

1. Open the cover of the remote control by putting your fingernail into the gap between the cover and body of the remote control. Then, lift the cover and separate it completely.
2. Install a 3V Lithium battery. Insert the battery into the battery compartment with the + side facing up.
3. Fit the remote control's cover to the remote control. Next, lower the cover so that it is flush with the body of the remote, and then press the cover into the body by pushing the edges down with your hand.



▪ Be careful not to catch your fingernail in the gap when you lift the cover. You can damage your fingernail.

Operation Range of the Remote Control

You can use the remote control up to 23 feet (7 meters) in a straight line from the unit. You can also operate the remote at a horizontal angle of up to 30° from the remote control sensor.

power on and volume control

TURNING THE POWER ON/OFF

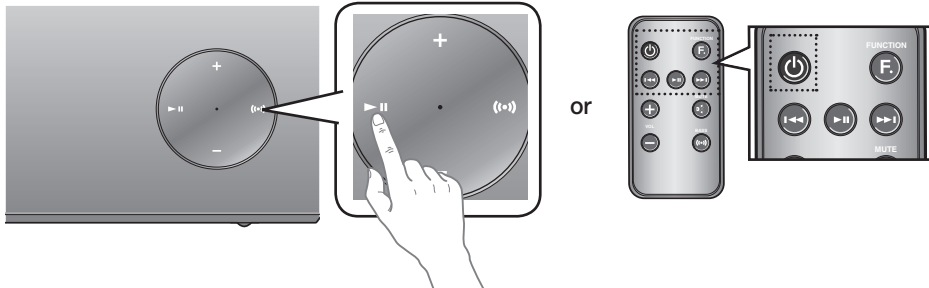

1. To turn on this unit, press any button on the unit's top panel when the unit is in Standby mode.
or,
Press **POWER** on the remote control.
2. To turn off this unit, press the ►|| button on the unit's top panel for more than 3 seconds.
or,
Press **POWER** on the remote control again.



- The standby LED is on when AC Plug is connected to the wall outlet and the Power of the unit is off. The standby LED is off when the power of the unit is on.
- The power of the unit automatically turns off if there is no input for 20 minutes.

ADJUSTING THE VOLUME

Use +, - buttons to adjust the volume. As you adjust the volume, the Input mode LED blinks. The LED remains on in case you increase the volume when it has already been set to maximum, or decrease the volume when it has already been set to minimum.



- Press the **+/-** button on the right side of the top panel.
or,
Press **VOL +/-** on the remote control.



- The volume level increases or decreases when you press VOL +/-.
- You can also use the volume controls of devices connected using the Dual Dock or Bluetooth to control the volume. However, your ability to control the volume using the volume controls of devices connected using Bluetooth may be limited.

USING THE SPACER COVER

Attach the space cover if you want to dock a Samsung Galaxy or Apple device having no protective case onto the Dual Dock.

- Use it for stable installation of your device considering the shape of the device.

The Dual Dock also comes with a protective cover for the 30-pin Apple device connector. Use the protective cover for the 30-pin connector when you attach the 5-pin Samsung Galaxy device.

See the illustrations below for additional instructions.

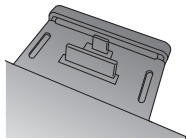
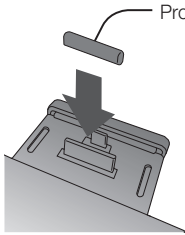
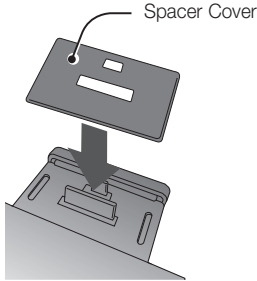
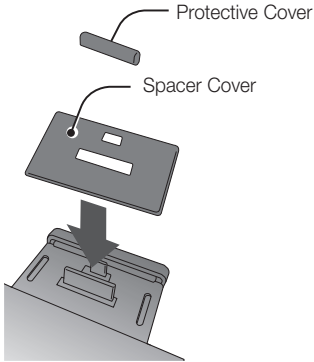
<For Apple Device Users>	<For Galaxy Device Users>
<p>When docking a device, use appropriate support considering the docking device's protective case or the device's shape for further stability.</p>	
	 <p>Protective Cover</p>
<p>Used for docking devices having no protective case on it.</p>	
 <p>Spacer Cover</p>	 <p>Protective Cover</p> <p>Spacer Cover</p>

- 
 It is impossible to attach a device to the Dual Dock that has a case thicker than 1.5 mm or an unusual rounded bottom.

CONNECTING A DEVICE TO THE DUAL DOCK

How to connect a device to the Dual Dock.

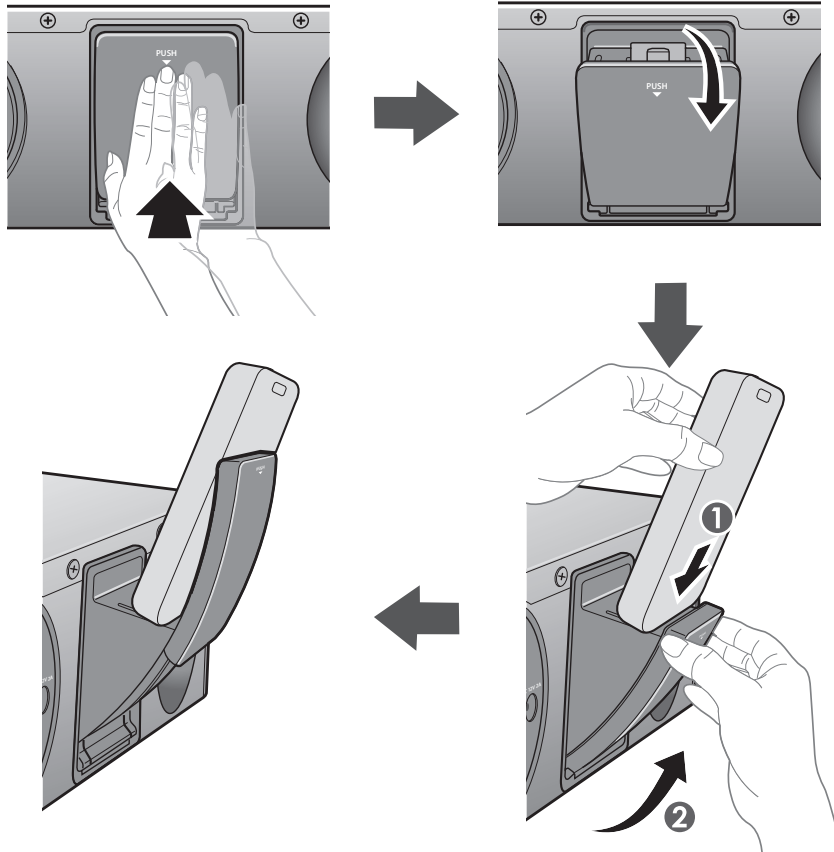

1. The **DUAL DOCK** is located on the back of the product. To open, push it in gently.
2. If you have a Samsung Galaxy device, connect the device to the 5 pin (smaller) connector to connect to the Dual Dock. If you have an Apple device, connect the device to the 30 pin (larger) connector on the Dual Dock.
3. Lift the device support up as shown to prevent the device from sliding or falling off the Dual Dock.



- Turn on your Samsung Galaxy device before you attach it to the Dual Dock.
- This unit doesn't support the simultaneous docking of Samsung Galaxy and Apple devices.
- Connect your Samsung Galaxy or Apple device to the Dual Dock before starting Docking mode. (See page 16)

CONNECTING AN AUDIO DEVICE USING AUX IN

This section explains how to connect the unit to an audio device.

This unit requires one analog audio jack for connecting to an audio device.

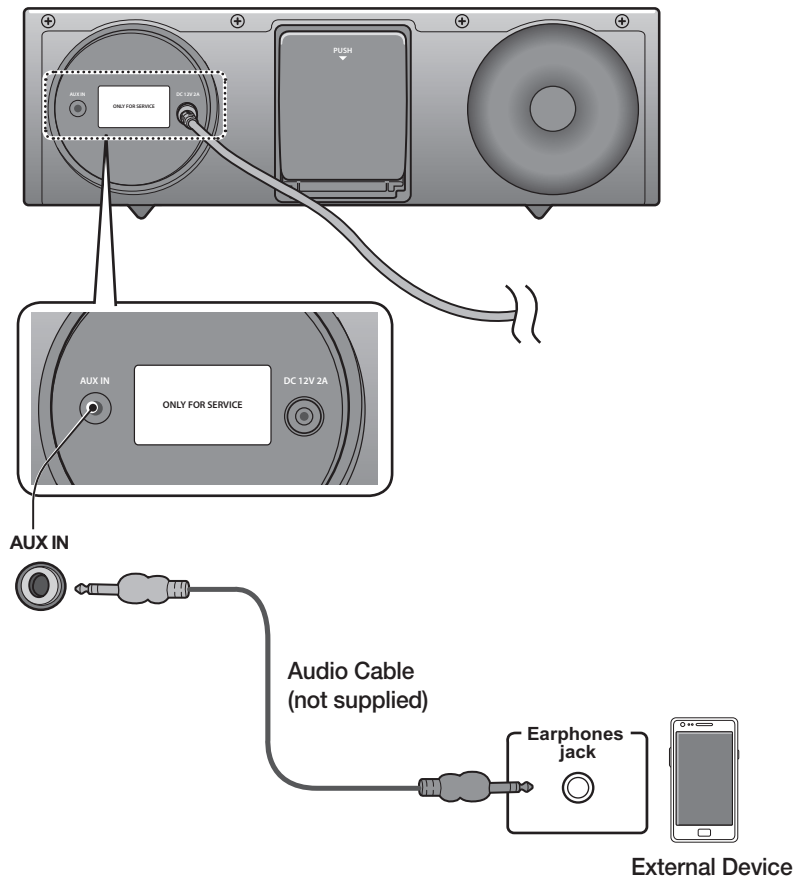

AUX IN

Connect AUX IN (Audio) on the back of the unit to the earphone jack of the external device or audio device.

If connected to an external device via AUX input while your Samsung Galaxy device is docked or connected to a Bluetooth device at the same time, the input source switches between the AUX and Samsung Galaxy or Bluetooth device by tapping the PAUSE button on the Samsung Galaxy / Bluetooth device. Tap it again to switch to the other input source.



- Use the Function key on the remote control to switch between connected devices, if there are multiple devices connected to the Docking station.
- Before moving or installing this product, be sure to turn off the power and disconnect the power cord.

BLUETOOTH

You can connect the Wireless Audio with Dock to Bluetooth devices and enjoy music with high quality stereo sound, all without wires!

What is Bluetooth?

Bluetooth technology lets Bluetooth-compliant devices interconnect easily with each other using a short wireless connection.

- A Bluetooth device may cause noise or malfunction, depending on usage, when:
 - A part of your body is in contact with the receiving/transmitting system of the Bluetooth device or the Wireless Audio with Dock.
 - It is subject to electrical variation from obstructions caused by a wall, corner, or by office partitioning.
 - It is exposed to electrical interference from same frequency-band devices including medical equipment, microwave ovens, and wireless LANs.
- Keep the Wireless Audio with Dock and the Bluetooth device close together when pairing.
- The further the distance between the Wireless Audio with Dock and Bluetooth device, the worse the quality. If the distance exceeds the Bluetooth operational range, the connection is lost.
- In poor reception-sensitivity areas, the Bluetooth connection may not work properly.
- The Bluetooth connection only works when the Bluetooth device is close to the set. The connection is automatically cut off if the Bluetooth device moves out of range. Even within range, the sound quality may be degraded by obstacles such as walls or doors.
- This wireless device may cause electric interference during its operation.



- You may be required to enter a PIN code (password) when connecting the Bluetooth device to the Wireless Audio with Dock. If the PIN code input window appears, enter <0000>.
- The Wireless Audio with Dock supports SBC data (44.1kHz, 48kHz).
- The AVRCP feature is not supported.
- Connect only to a Bluetooth device that supports the A2DP (AV) function.
- You cannot connect to a Bluetooth device that supports only the HF (Hands Free) function.
- Only one Bluetooth device can be paired at a time.
- Once you have turned off the Wireless Audio with Dock and the pairing is disconnected, the pairing will not be restored automatically. To reconnect, you must pair the devices again.
- The Wireless Audio with Dock may not search or connect properly in the following cases:
 - If there is a strong electrical field around the Wireless Audio with Dock.
 - If several Bluetooth devices are simultaneously paired to the Wireless Audio with Dock.
 - If the Bluetooth device is turned off, not in place, or malfunctions
 - Note that such devices as microwave ovens, wireless LAN adaptors, fluorescent lights, and gas stoves use the same frequency range as the Bluetooth device, which can cause electric interference.

CONNECTING TO BLUETOOTH DEVICES

This section explains how to connect the Wireless Audio with Dock to Bluetooth compatible devices.

To connect the Wireless Audio with Dock to a Bluetooth device

Before you begin, confirm that your Bluetooth device supports the Bluetooth compliant stereo headset function.

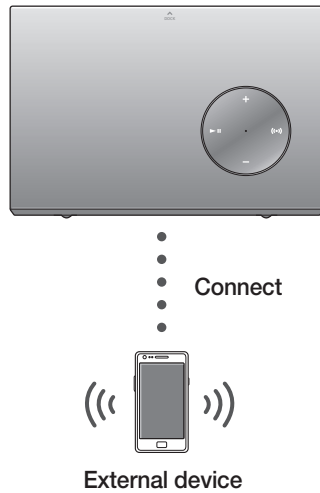

1. Select the Bluetooth menu on your Bluetooth device.
(Refer to the Bluetooth device's user manual for instructions.)
2. Scan or search for All Devices or for Headsets.
 - You will see a list of devices.
3. Select "[Samsung]W_Audio XXXXXX" from the searched list.
 - If the Bluetooth device fails to pair with the Wireless Audio with Dock, delete the "[Samsung]W_Audio XXXXXX" found by the Bluetooth device, and search for the Wireless Audio with Dock again, and then repeat Steps 1, 2, and 3.

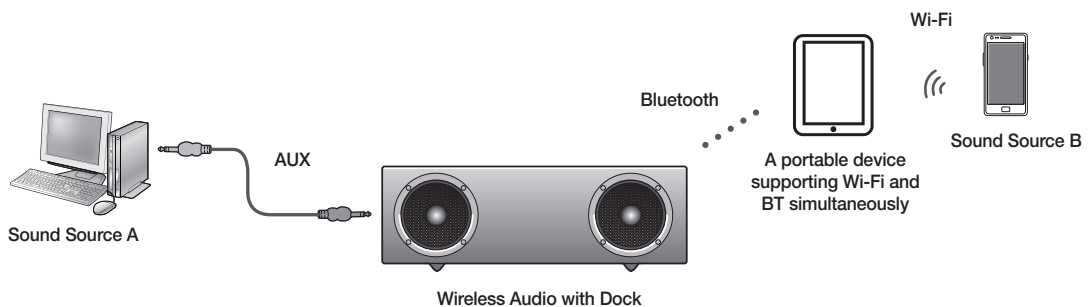

- When the AUX and Bluetooth operate at the same time as shown above, the sound may come from both simultaneously.

USING THE DOCKING MODE WITH SAMSUNG GALAXY AND APPLE DEVICES

Connect the Samsung Galaxy or Apple device to the Dual Dock. (See page 12)

<Samsung Galaxy Devices>

To use your Samsung Galaxy series device with the Dual Dock, you must download and install the Docking Mode application from the Android Market on the device. To download, follow these steps:

1. Tap the Play Store (Android Market) icon on the Samsung Galaxy device's main screen.
2. Tap the search icon on the screen to access the search bar.
3. In the search bar, type in the [**Samsung Wireless Audio Dock**], and then search.
4. In the search result list, find, and then tap [**Samsung Wireless Audio Dock**] to start downloading.
5. Tap [**install**].

To play music, follow these steps:

- 1-1. If you start the app when the Wireless Audio with Dock is the only device for the Bluetooth connection, selecting PLAY in your device automatically establishes the Bluetooth connection to the Wireless Audio with Dock and the unit plays music.
- 1-2. If there are multiple devices for Bluetooth connection including Wireless Audio with Dock,
 - 1) When you start the app, the list of the devices which you can connect to the Wireless Audio with Dock will appear.
 - 2) Play music after connecting to the Wireless Audio with Dock by selecting it on the list of devices.
 - If there exists a Bluetooth device paired to the Wireless Audio with Dock before, it will not appear in the list and be connected automatically.
2. If you replace the Wireless Audio with Dock which you have paired to your mobile device, you should delete the remaining settings saved in your device before pairing to the new one.
 -  → [**Clear data**].



- 
 - Once you started the application, running is not disturbed by charging your mobile device with an ordinary charger.
 - When you connect other device to the Wireless Audio with Dock after connecting Samsung Galaxy device in docking mode, you may have to turn off the Bluetooth mode of the Samsung Galaxy device.
 - If you have trouble connecting the Samsung Galaxy device to the Dual Dock, turn off the devices's Bluetooth mode.

<Apple Devices>

1. Select the mode as described above, and then connect the Apple device to the Dual Dock as described in Connecting a Device to the Dual Dock (Page 12). You will hear a ringing sound.
2. Select the <**Music**> menu in the main screen of the Apple device.
3. Select and play the desired music.
 - The music will play through the Wireless Audio with Dock's speakers.

- 
 - While playing a video with your device, Play/Pause/Next/Back operations may not be available. Use the button on your device to operate it.

Compatibility list (Apple Device)

Docking mode compatible iPod/iPhone models

Update the software of your iPod/iPhone to the latest version before using it with this unit.

- iPod touch (4th generation)
 - iPod touch (3rd generation)
 - iPod nano (6th generation)
 - iPod nano (5th generation)
 - iPhone 4S
 - iPhone 4
 - iPhone 3GS
 - iPod classic
 - Depending on its version of iPod Software, your device may not be compatible or may operate abnormally.
- ※ If you connect an incompatible Apple device, the Standby LED will blink.

USING THE BLUETOOTH MODE

Connect the Bluetooth device to the Wireless Audio with Dock. (See page 15)

To connect your Bluetooth device when the Wireless Audio with Dock is in Bluetooth mode, search for the Wireless Audio with Dock on the device's Bluetooth list. Select the Wireless Audio with Dock, and then connect. Once the Wireless Audio with Dock has connected, select and play the desired music.

The music will play through the Wireless Audio with Dock's speakers.



- If you want to change the device which is connected through Bluetooth mode to other device, disconnect the existing device and try to connect to the other device which you want to use.
- While in Bluetooth communication, Play/Pause/Next/Back operations may not be available depending on used mobile device and application.
- Operating Bluetooth device paired to the Wireless Audio with Dock may cause stuttering if operated while the Wireless Audio with Dock is playing back from AUX input.

To disconnect the Bluetooth device from the Wireless Audio with Dock

You can cancel Bluetooth pairing from the Wireless Audio with Dock. For instructions, see the Bluetooth device's user manual.

- The Wireless Audio with Dock will be disconnected.



- The Bluetooth connection only works when the Bluetooth device is close to the set. The connection is automatically cut off if the Bluetooth device moves out of range. Even within range, the sound quality may be degraded by obstacles such as walls or doors.
- If the Bluetooth device comes back into the effective range, you can restart to restore the pairing with the Bluetooth device.

functions

ADVANCED FUNCTIONS

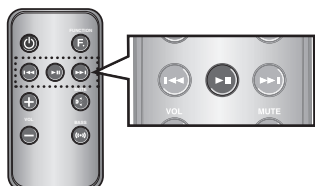

Play/Pause

During playback, press the ►|| button.

- Press the ►|| button to stop playing the file temporarily. Press the ►|| button again to play the selected file.



- This function does not operate in AUX mode.

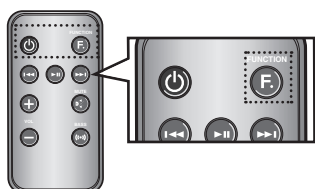

Using function

Change the mode to switch to Docking and AUX sources.

Press **FUNCTION** on the remote control of this unit.

- Each time the button is pressed, the selection changes as follows : iPod (iPhone) → Galaxy (Bluetooth) → AUX mode



- Check the function you want to use by pressing the Function button on the remote control when multiple devices are connected to the product simultaneously.

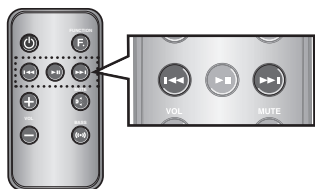

Skip Forward/Back

During playback, press the ◀◀, ▶▶ button.

- When there is more than one file and you press the ▶▶ button, the next file is selected.
- When there is more than one file and you press the ◀◀ button, the previous file is selected.



- This function does not operate in AUX mode.

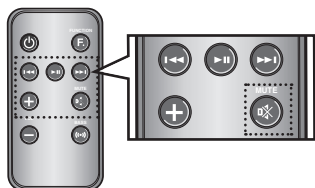

Muting the sound

This is useful when answering a doorbell or telephone call.

1. To mute sound of this unit, press the **MUTE** (🔇) button of the remote control.
2. Press **MUTE** (🔇) on the remote control again (or press **VOLUME +/-**) to restore the sound.

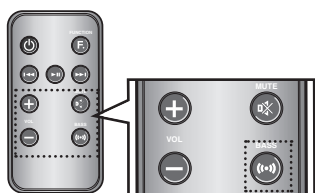

Using the BASS function

Lets you optimize the bass sound according to your tastes.

Press **BASS** on the remote control of this unit.

- Each time the button is pressed, the selection changes as follows : BASS ON → OFF

troubleshooting

Before requesting service, please check the following.

Symptom	Check	Remedy
The unit will not turn on.	<ul style="list-style-type: none">• Is the power cord plugged into the outlet?	<ul style="list-style-type: none">• Connect the power plug to the outlet.
A function does not work when the button is pressed.	<ul style="list-style-type: none">• Has the Wireless Audio with Dock or the remote been exposed to static electricity?	<ul style="list-style-type: none">• Disconnect the power plug and connect it again.
Sound is not produced.	<ul style="list-style-type: none">• Is the unit properly connected to device?• Is the Mute function on?• Is the volume set to minimum?	<ul style="list-style-type: none">• Connect it correctly.• Press the Mute button to cancel the function.• Adjust the volume.
The remote control does not work.	<ul style="list-style-type: none">• Are the batteries drained?• Is the distance between remote control and main unit too far?	<ul style="list-style-type: none">• Replace with new batteries.• Operate closer to the main unit.

appendix

SPECIFICATIONS

Model name	DA-E570	
GENERAL	Power supply	DC 12V 2A
	Power consumption	11.2W
	Weight	4.4 lbs
	Dimensions (W x D x H)	11.8 x 6.69 x 3.7 inches
	Operating temperature range	+41°F to +95°F
	Operating humidity range	10 % to 75 %
AMPLIFIER	Rated output power	5W/CH, 4OHM, THD = 10%, 1kHz
	Input sensitivity/Impedance	800mV/20Kohm
	S/N ratio (analog input)	65 dB
	Separation(1kHz)	60 dB
FREQUENCY RESPONSE	Analog input	20Hz~22kHz(±3 dB)
DOCKING RATING	iPod	5 V 1.0 A
	Galaxy	5 V 1.0 A

* S/N ratio, distortion, separation, and usable sensitivity are based on measurement using AES (Audio Engineering Society) guidelines.

* Nominal specification

- Samsung Electronics Co., Ltd reserves the right to change the specifications without notice.

- Weight and dimensions are approximate.

WARRANTY

LIMITED WARRANTY TO ORIGINAL PURCHASER

This SAMSUNG brand product, as supplied and distributed by Samsung Electronics America, Inc. (SAMSUNG) and delivered new, in the original carton to the original consumer purchaser, is warranted by SAMSUNG against manufacturing defects in materials and workmanship for a limited warranty period of:

One (1) Year Parts and Labor*

(*90 Days Parts and Labor for Commercial Use)

This limited warranty begins on the original date of purchase, and is valid only on products purchased and used in the United States. To receive warranty service, the purchaser must contact SAMSUNG for problem determination and service procedures. Warranty service can only be performed by a SAMSUNG authorized service center. The original dated bill of sale must be presented upon request as proof of purchase to SAMSUNG or SAMSUNG's authorized service center. Transportation of the product to and from the service center is the responsibility of the purchaser.

SAMSUNG will repair or replace this product, at our option and at no charge as stipulated herein, with new or reconditioned parts or products if found to be defective during the limited warranty period specified above. All replaced parts and products become the property of SAMSUNG and must be returned to SAMSUNG. Replacement parts and products assume the remaining original warranty, or ninety (90) days, whichever is longer.

SAMSUNG's obligations with respect to software products distributed by SAMSUNG under the SAMSUNG brand name are set forth in the applicable end user license agreement. Non-SAMSUNG hardware and software products, if provided, are on an "AS IS" basis. Non-SAMSUNG manufacturers, suppliers, publishers, and service providers may provide their own warranties.

This limited warranty covers manufacturing defects in materials and workmanship encountered in normal, and except to the extent otherwise expressly provided for in this statement, noncommercial use of this product, and shall not apply to the following, including, but not limited to: damage which occurs in shipment; delivery and installation; applications and uses for which this product was not intended; altered product or serial numbers; cosmetic damage or exterior finish; accidents, abuse, neglect, fire, water, lightning or other acts of nature; use of products, equipment, systems, utilities, services, parts, supplies, accessories, applications, installations, repairs, external wiring or connectors not supplied and authorized by SAMSUNG, or which damage this product or result in service problems; incorrect electrical line voltage, fluctuations and surges; customer adjustments and failure to follow operating instructions, cleaning, maintenance and environmental instructions that are covered and prescribed in the instruction book; product removal or reinstallation; reception problems and distortion related to noise, echo, interference or other signal transmission and delivery problems. SAMSUNG does not warrant uninterrupted or error-free operation of the product.

THERE ARE NO EXPRESS WARRANTIES OTHER THAN THOSE LISTED AND DESCRIBED ABOVE, AND NO WARRANTIES WHETHER EXPRESS OR IMPLIED, INCLUDING, BUT NOT LIMITED TO, ANY IMPLIED WARRANTIES OF MERCHANTABILITY OR FITNESS FOR A PARTICULAR PURPOSE, SHALL APPLY AFTER THE EXPRESS WARRANTY PERIODS STATED ABOVE, AND NO OTHER EXPRESS WARRANTY OR GUARANTY GIVEN BY ANY PERSON, FIRM OR CORPORATION WITH RESPECT TO THIS PRODUCT SHALL BE BINDING ON SAMSUNG. SAMSUNG SHALL NOT BE LIABLE FOR LOSS OF REVENUE OR PROFITS, FAILURE TO REALIZE SAVINGS OR OTHER BENEFITS, OR ANY OTHER SPECIAL, INCIDENTAL OR CONSEQUENTIAL DAMAGES CAUSED BY THE USE, MISUSE OR INABILITY TO USE THIS PRODUCT, REGARDLESS OF THE LEGAL THEORY ON WHICH THE CLAIM IS BASED, AND EVEN IF SAMSUNG HAS BEEN ADVISED OF THE POSSIBILITY OF SUCH DAMAGES. NOR SHALL RECOVERY OF ANY KIND AGAINST SAMSUNG BE GREATER IN AMOUNT THAN THE PURCHASE PRICE OF THE PRODUCT SOLD BY SAMSUNG AND CAUSING THE ALLEGED DAMAGE. WITHOUT LIMITING THE FOREGOING, PURCHASER ASSUMES ALL RISK AND LIABILITY FOR LOSS, DAMAGE OR INJURY TO PURCHASER AND PURCHASER'S PROPERTY AND TO OTHERS AND THEIR PROPERTY ARISING OUT OF THE USE, MISUSE OR INABILITY TO USE THIS PRODUCT SOLD BY SAMSUNG NOT CAUSED DIRECTLY BY THE NEGLIGENCE OF SAMSUNG. THIS LIMITED WARRANTY SHALL NOT EXTEND TO ANYONE OTHER THAN THE ORIGINAL PURCHASER OF THIS PRODUCT, IS NONTRANSFERABLE AND STATES YOUR EXCLUSIVE REMEDY.

Some states do not allow limitations on how long an implied warranty lasts, or the exclusion or limitation of incidental or consequential damages, so the above limitations or exclusions may not apply to you. This warranty gives you specific legal rights, and you may also have other rights which vary from state to state.

To obtain warranty hardware service, please contact SAMSUNG customer care center.



QUESTIONS OR COMMENTS?

COUNTRY	CALL	OR VISIT US ONLINE AT	WRITE
IN THE US	1-800-SAMSUNG (726-7864)	www.samsung.com/us	Samsung Electronics America, Inc. 85 Challenger Road Ridgefield Park, NJ 07660-2112



Code No. AH68-02475E (01)